



PROJECT
CATALOG #
TYPE
NOTES

NP Up Light **DESIGNER PLUS**

Expertly engineered with 45° or 60° shroud options to illuminate a variety of spaces in 3, 6, or 9 LED. An RGBW version is also available for use with **Luxor® ZDC** systems.

Quick Facts

- Die-cast aluminum
- Two-layer marine-grade anodization and powder coat finish
- Cree® integrated LEDs
- ProAim™ adjustability
- Tamper-resistant features
- Color temperature filters
- Compatible with Luxor technology
- Phase and PWM dimmable
- Input voltage: 10-15V

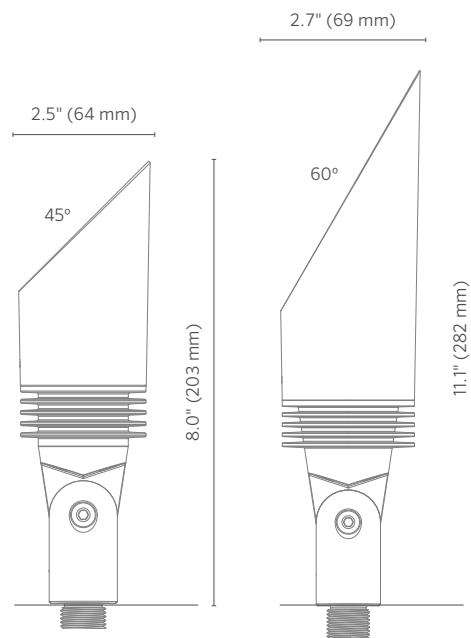

NP Up Light SPECIFICATIONS

Output	3LED	6LED	9LED	ZDC
Total Lumens†	135	280	360	110
Input Voltage	10 to 15V	10 to 15V	10 to 15V	11 to 15V
Input Power (W):	4.2	10.1	11.2	9.1
VA	4.5	13.5	13.5	11.0
Efficacy (Lumens/Watt)	32	28	32	21
Color Rendering Index (CRI)	80+	80+	80+	80+
Center Beam Candlepower*				
Spot (17-20)	464	1,069	897	172
Dimming	PWM, Phase**	PWM, Phase**	PWM, Phase**	--
RGBW Available	No	No	No	Yes
Luxor Compatibility				
Default	Zoning	Zoning	Zoning	--
ZD Option	Zoning/Dimming	Zoning/Dimming	Zoning/Dimming	--
ZDC Option	--	--	--	Zoning/Dimming/ Color
Minimum Rated Life (L70)	50,000 Hrs	50,000 Hrs	50,000 Hrs	50,000 Hrs

* Information not available for Flood or Wide Flood.

** For optimal performance, use a trailing-edge, phase-cut dimmer.

† Measured using the 3,900K CCT lens. Multipliers for other CCTs include 0.80 (2,700K), 0.65 (4,500K), and 0.65 (5,200K).

FX Luminaire

FX Luminaire is an industry-leading manufacturer of landscape and architectural lighting products with a focus on the advancement of LED technology and digital lighting control with zoning, dimming, and color adjustment capabilities. We offer a full spectrum of specification-driven lighting fixtures that can be utilized to create elegant, cutting-edge landscape lighting systems for commercial or residential applications. Our products are available exclusively via our extensive professional distributor network.

Materials

Die-cast aluminum A380 housing and shroud with stainless steel hardware. Die-cast zinc/aluminum alloy knuckle.

Socket

Socket contains MoistureBlock™ technology, preventing moisture from wicking up into sealed areas of the fixture.

Lamp

Integrated module with Cree LEDs. Gold-plated connectors and conformal coated for maximum reliability and corrosion resistance. Proprietary on-board intelligent driver uses firmware-controlled temperature regulation, maximizing LED life. Field upgradeable and replaceable, the LEDs are rated to 50,000 hrs. Maximum drive current: 1 A.

Optics

Polycarbonate color temperature adjustment lenses included with fixture: 2,700K (preinstalled), 3,900K (no lens), 4,500K, and 5,200K. Interchangeable optics for 10°, 20°, 30°-32°, or 55°-58° distributions ordered pre-assembled to fixture. Color temperature and beam angle lenses field serviceable. For additional color filters, spread lenses, hex baffles, etc., use MR-16 sized accessories (MR-16: 1.95" (495 mm) dia. x 1.1 mm thickness). Beam angle is calculated using LM-79 method for SSL luminaires.

Wiring

18 AWG (1 mm); SPT-1W; 220°F (105°C); 300V; 10' (3 m) length, pre-stripped.

Power

Input 10-15VAC/VDC 50/60Hz. Remote transformer required (specify separately).

Housing

Die-cast aluminum housing with capacity for 1LED, 3LED, 6LED, 9LED, or ZDC integrated LEDs.

Shroud

Die-cast aluminum shroud with 45° cutoff (standard) or 60° long shroud option.

Knuckle

Die-cast zinc/aluminum alloy knuckle with ½"-14 (13 mm) NPSM threads. Compress and lock features prevent slip after installation. 9° increments adjustability over 220° of vertical adjustment.

Lens

Tempered glass lens with shock resistance and high tolerance for thermal expansion and stress.

Weight

1.9 lbs. (0.9 kg)

Finish

Two-layer protection of sulfuric acid anodization and polyester TGIC powder coat, providing superior outdoor weathering in all conditions. Tested to ASTM standards.

Hardware

Stainless steel angle lock screw. Includes 10" (254 mm) ABS slotted installation spike.

International Compliance

Compliant per IEC 60598-1 and IEC 60598-2-7 when used with International Spike Kit ("EKITSPIKE") or alternate mount greater than or equal to IP65, or by selecting the "e" version.

Ambient Operating Temperature

0°F to 140°F (-18°C to 60°C)

Sustainability

Innovation meets conservation in the design and manufacturing of our products. Where we can, we use recycled materials while maintaining superior functionality. Our LED products provide high-quality light at optimal

energy efficiency, lifespan, and durability.

Installation Requirements

Designed for installation in the upward direction only.

Control

ZD or ZDC options utilize Luxor technology to zone light fixtures in up to 250 groups, dim each group in 1% increments between 0 and 100%, or change to one of 30,000 colors with RGBW LEDs. Select the ZD option for zoning/dimming or ZDC for zoning/dimming/color. Standard fixture is zoneable with Luxor.

Manufacturing

ISO 9001:2015 certified facility









Warranty

10-year limited warranty.

Listings



NP Up Light ORDERING INFORMATION



Fixture	Luxor Option	Output	Compliance	Shroud	Finish	
NP*	■ [default] Zone	■ 3LED 135 Lumens	■ [default] ½" (13 mm) thread UL-Listed	■ [default] Standard Shroud (45°)	■ BZ Bronze Metallic	
	■ ZD Zone/Dim	■ 6LED 280 Lumens	■ e Bracket Mount CE Approved	■ LS Long Shroud (60°)	■ DG Desert Granite	
		■ 9LED 360 Lumens			■ WI Weathered Iron	
	■ ZDC Zone/Dim/Color	■ [default] 110 Lumens			■ SB Sedona Brown	
					■ FB Black	
					■ FW Flat White	
					■ WG White Gloss	
					■ AL Almond	
					■ SV Silver	

EXAMPLE FIXTURE CONFIGURATION: NP-ZD-6LED-BZ
 * Ships with Super Slot Spike (753900)



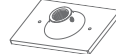

NP Up Light ORDERING INFORMATION

MOUNTING OPTIONS: Specify Separately



Mounts	Catalog No.	
■ SUPER SLOT SPIKE 2.5" (64 mm) x 10" (254 mm)	753900	
■ LONG SLOT SPIKE 2.5" (64 mm) x 12" (305 mm)	250015840000	
■ SUPER J-BOX 2.5" (64 mm) x 12" (305 mm)	SJ-XX*	
■ POST MOUNT 2.5" (64 mm) x 13" (330 mm)	PM-XX*	
■ JUNCTION BOX SPIKE KIT 3.35" (85 mm) x 12" (305 mm)	EKITSPIKE	
■ GROUND MOUNT 2.7" (67 mm) Diameter	GM-XX*	
■ VERSABOX® 2.2" (57 mm) x 1.5" (39 mm)	VB-050-XX*	
■ MINI J-BOX 3.5" (89 mm) x 1.3" (34 mm)	MJ-050-XX*	
■ TREEBOX 5.4" (138 mm) x 1.9" (49 mm)	TB-XX*	
■ GUTTER MOUNT 4.0" (102 mm) x 4.0" (102 mm)	GM-SS	
■ WALL PLATES 3.4" (85 mm) x 5.1" (129 mm)	WP-1G-050-XX*	
■ WALL PLATES 5.0" (127 mm) Diameter	WP-RD-050-XX*	

RISER OPTIONS: Specify Separately

Riser	Code	
■ RISER 0.8" (21 mm) Diameter	YY-R-XX*	
■ SIGN LIGHT RISER 0.8" (21 mm) Diameter w/ 45° Inward Curve	YY-R-SL-XX*	

*YY = riser height in inches (6" increments between 6" and 36"; 150 mm increments between 150 mm and 900 mm), XX = finish code

COUPLING OPTIONS: Specify Separately

Couplings	Code	
■ STRAIGHT 1.3" (32 mm) x 2.0" (51 mm)	COUP-XX*	
■ 90° ELBOW 1.3" (32 mm) x 2.0" (51 mm)	ELBW-050-XX*	
■ T-MOUNT 3.0" (76 mm) x 2.2" (57 mm)	TMNT-050-XX*	

LENS ACCESSORIES: Specify Separately

Item	Code	
■ HEX BAFFLE MR-16 Size	250015260000	
■ LINEAR SPREAD LENS MR-16 Size	250013550000	
■ SOLITE SPREAD LENS MR-16 Size	250015240000	

BEAM ANGLE LENSES: Specify Separately

Lens Options	1LED	3LED	6/9LED
■ DIFFUSER 18° (preassembled)	■ 770600	■ 771300	■ 771600
■ FLOOD LENS 35° (1 notch)	■ 1LEDFLENS	■ 3LEDFLENS	■ 9LEDFLENS
■ WIDE FLOOD LENS 60° (2 notches)	■ 1LEDWFLENS	■ 3LEDWFLENS	■ 9LEDWFLENS

NP Up Light PHOTOMETRICS

NP 1LED Illuminance at a Distance

Feet (Meters)	Center Beam	Beam Width	
	Foot-Candle (Lux)	Vertical 19.3°	Horizontal 19.9°
4.2' (1.3 m)	13.5 fc (144 lx)	1.7' (0.5 m)	1.7' (0.5 m)
8.3' (2.5 m)	3.3 fc (36 lx)	3.4' (1.0 m)	3.4' (1.0 m)
12.5' (2.8 m)	1.5 fc (16 lx)	5.2' (1.6 m)	5.1' (1.6 m)
16.7' (5.1 m)	0.8 fc (9 lx)	6.9' (2.1 m)	6.8' (2.1 m)
20.8' (6.3 m)	0.5 fc (6 lx)	8.6' (2.6 m)	8.4' (2.6 m)
25.0' (7.6 m)	0.4 fc (4 lx)	10.3' (3.1 m)	10.1' (3.1 m)

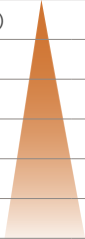

NP 3LED Illuminance at a Distance

Feet (Meters)	Center Beam	Beam Width	
	Foot-Candle (Lux)	Vertical 19.3°	Horizontal 19.9°
4.2' (1.3 m)	26.7 fc (288 lx)	1.8' (0.6 m)	1.8' (0.6 m)
8.3' (2.5 m)	6.7 fc (72 lx)	3.6' (1.1 m)	3.6' (1.1 m)
12.5' (2.8 m)	3 fc (32 lx)	5.5' (1.7 m)	5.4' (1.7 m)
16.7' (5.1 m)	1.7 fc (18 lx)	7.3' (2.2 m)	7.2' (2.2 m)
20.8' (6.3 m)	1.1 fc (16 lx)	9.1' (2.8 m)	9.04' (2.8 m)
25.0' (7.6 m)	0.74 fc (8 lx)	10.9' (3.3 m)	10.8' (3.3 m)

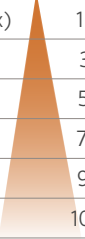

NP 6LED Illuminance at a Distance

Feet (Meters)	Center Beam	Beam Width	
	Foot-Candle (Lux)	Vertical 19.3°	Horizontal 19.9°
4.2' (1.3 m)	61.6 fc (663 lx)	1.8' (0.6 m)	1.8' (0.6 m)
8.3' (2.5 m)	15.4 fc (166 lx)	3.6' (1.1 m)	3.6' (1.1 m)
12.5' (2.8 m)	6.8 fc (74 lx)	5.4' (1.7 m)	5.4' (1.7 m)
16.7' (5.1 m)	3.9 fc (41 lx)	7.2' (2.2 m)	7.2' (2.2 m)
20.8' (6.3 m)	2.5 fc (27 lx)	9.0' (2.7 m)	9.04' (2.8 m)
25.0' (7.6 m)	1.7 fc (15 lx)	10.8' (3.3 m)	10.8' (3.3 m)

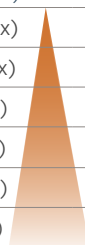

NP 9LED Illuminance at a Distance

Feet (Meters)	Center Beam	Beam Width	
	Foot-Candle (Lux)	Vertical 19.3°	Horizontal 19.9°
4.2' (1.3 m)	72.4 fc (779 lx)	1.8' (0.6 m)	1.8' (0.6 m)
8.3' (2.5 m)	28.4 fc (306 lx)	3.6' (1.1 m)	3.5' (1.1 m)
12.5' (2.8 m)	8.0 fc (87 lx)	5.4' (1.7 m)	5.3' (1.6 m)
16.7' (5.1 m)	4.5 fc (49 lx)	7.1' (2.2 m)	7.1' (2.2 m)
20.8' (6.3 m)	2.9 fc (31 lx)	8.9' (2.7 m)	8.9' (2.7 m)
25.0' (7.6 m)	2.0 fc (22 lx)	10.7' (3.3 m)	10.6' (3.2 m)

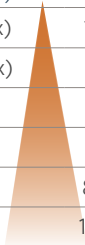

NP zDC Illuminance at a Distance

Feet (Meters)	Center Beam	Beam Width	
	Foot-Candle (Lux)	Vertical 38.3°	Horizontal 40.4°
4.2' (1.3 m)	11.6 fc (125 lx)	2.8' (0.9 m)	2.9' (0.9 m)
8.3' (2.5 m)	2.9 fc (31 lx)	5.6' (1.7 m)	5.9' (1.8 m)
12.5' (2.8 m)	1.3 fc (14 lx)	8.3' (2.5 m)	8.8' (2.7 m)
16.7' (5.1 m)	0.7 fc (8 lx)	11.1' (3.4 m)	11.8' (3.6 m)
20.8' (6.3 m)	0.5 fc (5 lx)	13.9' (4.2 m)	14.7' (4.5 m)
25.0' (7.6 m)	0.3 fc (3.5 lx)	16.7' (5.1 m)	17.7' (5.4 m)

